

9500CT / 9500SSCT

COMMERCIAL EXTRA HEAVY-DUTY
PLASTIC TOILET SEAT

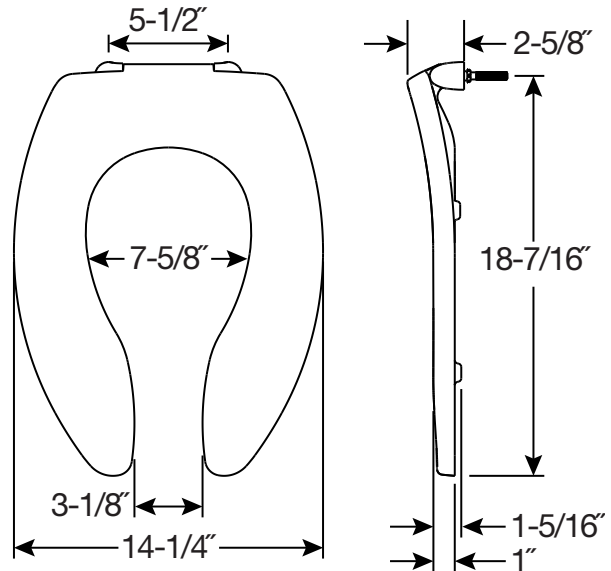

FEATURES:

- **STA-TITE® Commercial Fastening System™**
Eliminates callbacks for loosened seats

SPECIFICATIONS:

Size: Elongated

Material: Plastic

Style: Open Front less Cover

Ring Bumpers: Four

Hinges: Plastic Non Self-Sustaining Check Hinges (9500CT) or Self-Sustaining Check Hinges (9500SSCT) with Non-Corroding 300 Series Stainless Steel Posts and Pintles

Hardware: STA-TITE® Commercial Fastening System™

Codes & Standards:



Complies with
IAPMO/ANSI Z124.5
Performance Standards
Heavy-Duty Commercial



Proudly Made in the USA

Eco-Friendly

