



HAVEN 3000

OWNER'S MANUAL





PRODUCT INFORMATION

Safety Precautions.....4
Parts.....6
Product.....7
Dimensions.....8
Remote Control.....9

PRODUCT INSTALLATION

Seat Installation.....10
Remote Control Installation.....19

PRODUCT OPERATION

How to Use.....14
Maintenance & Cleaning.....18

TROUBLESHOOTING

Tips & Specifications.....21
Troubleshooting & Warranty.....22

IMPORTANT SAFEGUARDS

- When using electrical products, especially when children are present, basic safety precautions should always be followed.

READ ALL INSTRUCTIONS BEFORE USING

- Do not overtighten any connections.
- For use with 120V 60Hz: Power supply must be a 15 Amp GFCI outlet.
- The electrical cord must be connected to a GFCI outlet.
- The GFCI outlet should be 1 ft. above the floor.
- Install only in well-ventilated areas to avoid excess humidity.
- Do not install in narrow toilet stalls or in shower stalls.
- Install only where direct contact with water is minimized.
- Do not install near any heat source.
- Avoid using extension cords if possible. Consult with a certified electrician where extension cords are necessary.

DANGER - TO REDUCE THE RISK OF ELECTROCUTION

- Do not use while bathing.
- Do not place or store product where it can fall or be pulled into a tub or sink.
- Do not place or drop into water or other liquid,
- Do not reach for a product that has fallen into water. Unplug immediately.

WARNING - TO REDUCE THE RISK OF BURNS, ELECTROCUTION OR INJURY TO PERSONS:

- Close supervision is necessary when this product is used by, on, or near children.
- Use this product only for its intended use as described in this manual. Only use attachments recommended by the manufacturer.
- Never operate this product if it has a damaged cord or plug, if it is not working properly, has been dropped or damaged, or has been dipped into water. Return the product to a service center for examination and repair.
- Keep the cord away from heated surfaces.
- Never drop or insert any objects into any opening or hose.
- Do not use outdoors or operate where aerosol (spray) products are being used or where oxygen is being administered.
- Connect this product to a properly grounded outlet only. See grounding instructions.
- Unplug this product before filling. Fill (reservoir) with water only.

SAVE THESE INSTRUCTIONS



2 Top Mount
Metal Bolts



2 AAA Batteries



Bracket
Holder

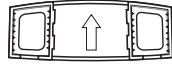

Catch Plate



2 Top Mount
Rubber Nuts



Bidet Water
Supply Hose



2 Washers

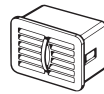

Deodorizer
Cartridge



T-Valve 7/8"



Remote Control &
Remote Control Holder

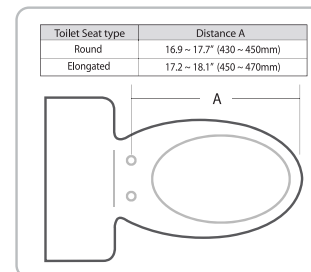
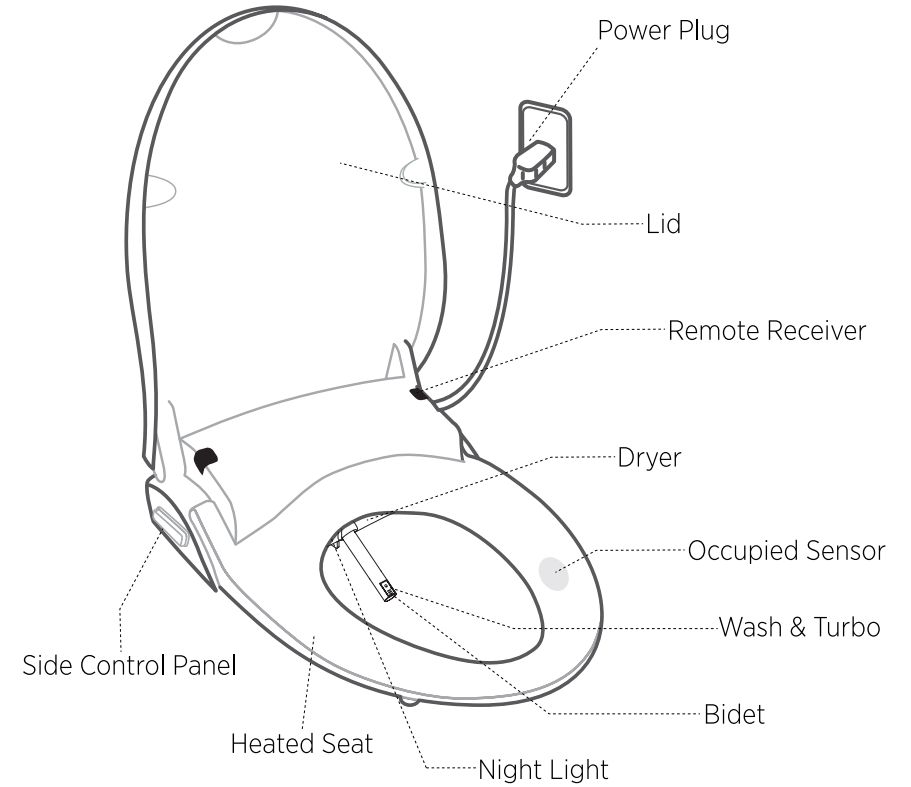

Elongated

Round

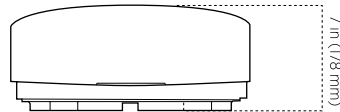
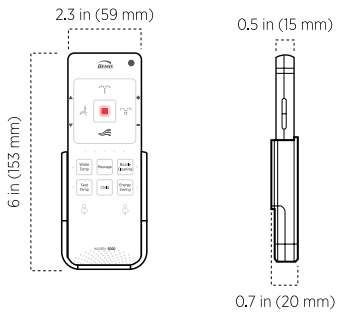
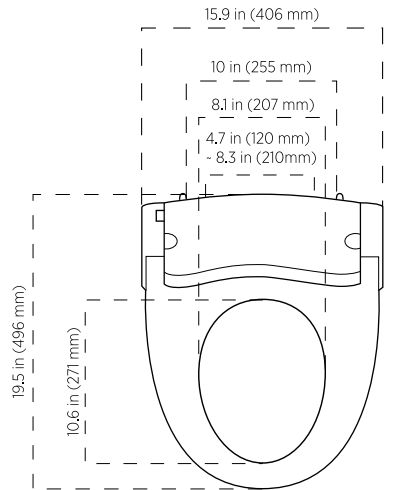
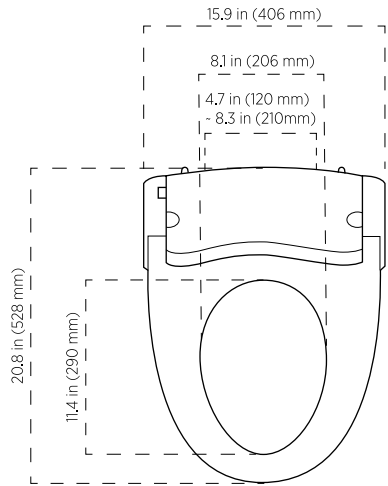

WASH

Runs wash function.
(1 minute)

STOP

Stops any operations

BIDET

Runs bidet function
(1 minute)

▲▼

Controls nozzle position

MASSAGE

Runs massage function during wash/bidet/turbo

WATER TEMP

Controls water temperature (off/low/mid/high)

SEAT TEMP

Controls seat temperature (off/low/mid/high)

USER PRESET

Users can save preferred settings

TURBO

Turbo function
(1 minute)

NIGHT LIGHT

When not seated, press "+" for longer than 3 sec.

+/-

Controls water pressure & dry temperature

DRY

Dry function
(3 minutes)

NOZZLE CLEANING

Rinses nozzle 3 times and extends for manual cleaning

ENERGY SAVING

Yellow: ECO 1
Green: ECO 2
Off/OFF

CHILD

Automatic child safety mode

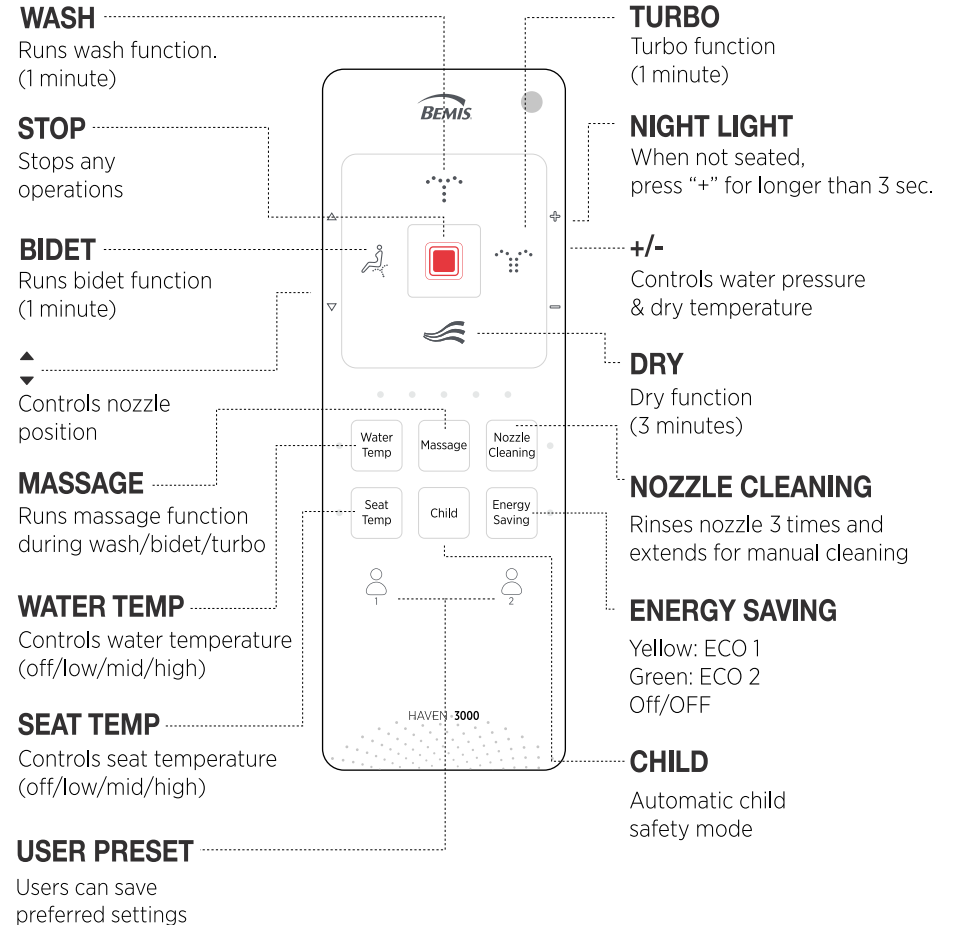

1. Remove the seat from the existing toilet body.

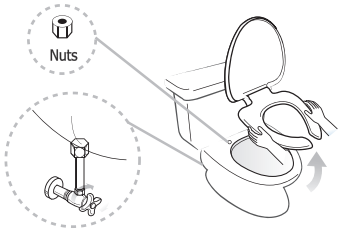

- Release the nuts, and then remove the seat and cover.
- Store the seat in a proper place for future use.
- Turn off the water.

2. Install the T-Valve.

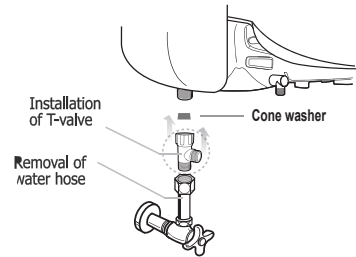

- Remove the existing water hose and then install T-valve to the bottom of the toilet tank. Ensure the rubber washer is properly seated and attach the original water hose to the T-Valve.
- To avoid damage to product or property, do not overtighten the T-Valve or hoses.

3. Fix the catch plate onto the toilet.

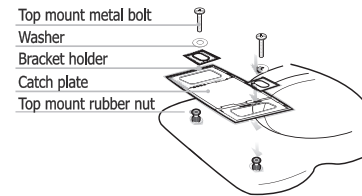

- Point the arrow on the catch plate towards the toilet tank.

4. Push the main body toward the catch plate completely.

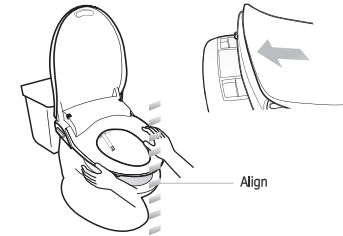

- Push it until you hear a “click”.
- When the product is not installed well, it may cause leakage.
- Adjust as needed before tightening bolts. Do not over tighten the bolts.

5. Connect bidet hose.

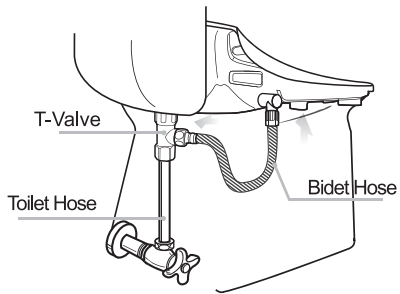

- After installing the T-valve, connect the supplied bidet hose from the center of the T-valve to the bidet.
- Connect the toilet hose to the bottom of the T-valve.

6. Deodorizing Cartridge

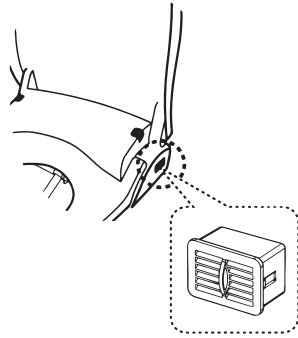

- Insert the deodorizing cartridge into the bidet body.

7. Plug it in!



- Plug in and be sure that the nozzle extends and retracts when powered on.
- Do not plug the power cord in with wet hands. Risk of electric shock.

8. Turn on the water and check for leaks.

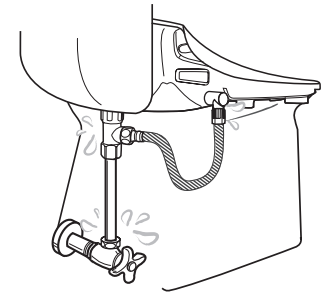

- If leak occurs, check to make sure all connections are properly sealed. Contact Bemis support for assistance.

Using inline carbon filter

Use of external water filter is only recommended in areas with known hard water issues. If a filter is used, it must be replaced every 3 months. This product is designed and intended for use exclusively with Bemis DIB water filters. The purchase or use of any other water filter is not the responsibility of Bemis. As such, any use of non DIB water filters is prohibited and will void the warranty for those Bemis products. Bemis will not be responsible for any resulting damages or claims related to the misuse or distribution of non Bemis DIB filters.

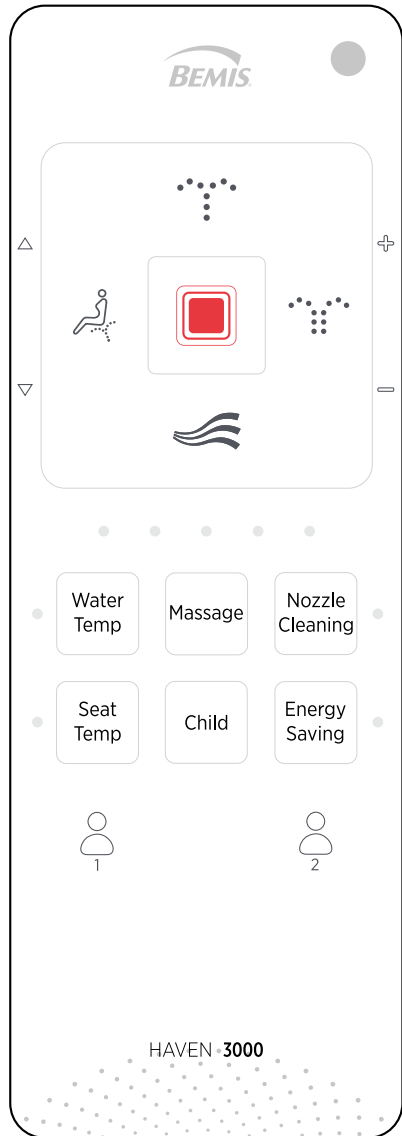

1. Sit On The Toilet Seat

- Be sure to sit on the seat sensor. If the sensor is not occupied, all functions will not open.

2. Wash, Bidet, Turbo

- Selected function can be used as described.
- When pressing the selected function again, the nozzle will oscillate back and forth to wash a wider range.
- Press the button once again to stop oscillate function
- The specialized water spray in Turbo function helps relieve constipation.

3. Dry Temperature Control

- Dryer operates for 3 minutes.
- Dryer temperature is adjustable by pressing “+” or “-” buttons.
- Dryer effect will be improved if you wipe the moisture before operating the drying function.

4. Massage

- Press the Massage button after activating a cleansing function for a pulsating effect.

5. Child Function

- Select this function to fully extend the nozzle and activate a low pressure and low temperature wash.

6. Nozzle Position Control & Water Pressure Control

- Press the corresponding arrow buttons to adjust the nozzle position and water pressure after a wash has been activated.

7. Stop

- Hold for 3 seconds to turn off. All operations will stop.

8. Energy Saving Function

- Yellow - Seat and water temperature will be maintained at 89 °F until occupied.
- Green - Seat and water heater are turned off until occupied.
- Off - Energy saving deactivated.

9. Seat/Water Temperature Control

- Press the corresponding button to cycle through the preset temperature options for the water and seat. The seat temperature will automatically reduce when occupied for more than 15 minutes.

10. Nozzle Cleaning

- Activates 3 rinse cycles before extending the nozzle for manual cleaning. Press the stop button when finished.

11. Night Light

- Hold the “+” button for 3 seconds while the seat is not occupied to turn on/off.

12. Automatic Tank Draining

- The tank will automatically drain and refill if the seat is not used for 48 hours. Hold the Stop and Water Temp buttons for 3 seconds to turn on/off.

13. Sitz Bath

- Press the nozzle cleaning button after selecting a cleansing function to activate a 5 minute low pressure wash.

14. Seat Sensor Bypass

- Hold the massage button for 3 seconds to activate or deactivate the seat sensor. This will allow the seat to be used without being occupied.

15. Reset

- Hold the stop button on the side control panel for 5 seconds. The seat will turn off after 3 seconds. Keep holding for another 2 seconds to complete the factory reset.

16. User Preset

- Nozzle position, water pressure, and temperature settings can be preset and stored for 2 users.

How To Set Up User Presets

- Activate a cleansing function and adjust the settings to your preference.
- Preset 1: Press and hold the stop ▲ and buttons together for 3 seconds.
- Preset 2: Press and hold the stop ▼ and buttons together for 3 seconds.
- Press the stop button or simply wait to complete setup.

How To Activate User Presets

- Activate a wash cycle.
- Press the selected user preset button to automatically apply settings.

17. Deodorizer

- The deodorizer is turned on by default. To turn it off, press and hold the STOP and ENERGY SAVING buttons for 3 seconds

Cleaning Instructions

- Avoid using harsh cleaners to preserve the plastic material of the bidet seat. Wipe the surface with a damp cloth or neutral cleaning solution. Do not splash water onto the power plug.

Screen Filter Cleaning

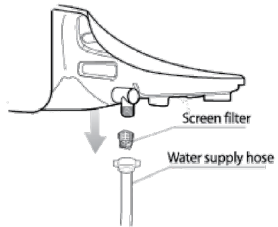

1. Close the water valve.
2. Disconnect the water supply hose. Take the screen filter out and clean it with a soft brush.
3. Return the filter after cleaning and reconnect the water supply hose.
4. Open the water valve.

Draining of Tank

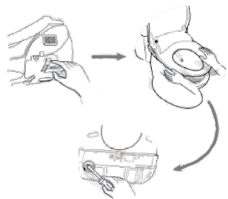

1. Remove the power plug from the outlet.
2. Close the water valve.
3. Press the release button and gently pull to remove the unit from the catch plate.
4. Use a flat-head screwdriver to open the drain plug.
5. The tank should be drained when the bidet seat is not going to be used for an extended period of time.

1. Remove the adhesive protection.

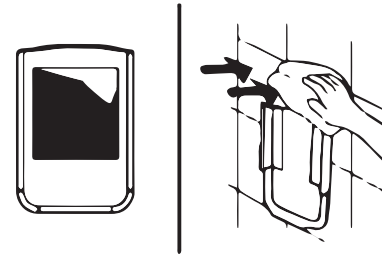

- Remove the adhesive protection to attach the remote control bracket to the wall or other surface.
- Clean and dry the area thoroughly before attaching the brackets.

2. Insert 2 “AAA” type batteries.

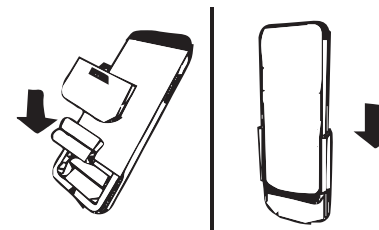

- Insert AAA type batteries.
- Identify a location in the bathroom for the remote control that is visible and reachable from the toilet.

3. Battery life.

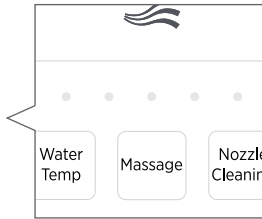

- When the batteries have reached the end of service life, all LEDs (5 points) will blink. Replace the batteries with new AAA batteries.
- Do not use old and new batteries together. This could cause damage or failure of the remote control.

4. Test unit out.

- After replacing the batteries, ID of the unit will be reset to “00”
 - If you have multiple bidet seats and want to change the remote ID, please see below.
1. Press Nozzle Control “ ▾ ” for 3 seconds. The indicator of “Nozzle Cleaning” blinks and the unit is ready for ID setting.
 2. Set the ID by pressing Power Control “+” or “-” (1-5 IDs available)
 3. Press “Stop” to save the ID. The main unit will be synchronized simultaneously.

ITEM		HAVEN 3000
Rated voltage		AC 120V, 60Hz
Max. Power consumption		870W
Power cord length		1.2 m
Recommended inlet water pressure		9.95-106.7 psi
Wash	Wash Volume	0.13-0.21 gal/min
	Heater Capacity	800W
Heated Seat	Temperature Control	4 levels (off-low-middle-high)
	Heater Capacity	55W
Dry	Temperature Control	Room temp. - 122°F
	Heater Capacity	250W
Deodorization		Catalytic Deodorization
Feed water temp. tolerance range		37-95°F (recommended 54-95°F)
Usage room temp. tolerance range		37-104°F (recommended 50-95°F)
Dimension	Elongated	15.9" (406) x 20.8" (528) x 7.0" (178)
	Round	15.9" (406) x 19.5" (496) x 7.0" (178)
Weight Net Weight (Gross Weight)	Elongated	10.5 lb (15.2)
	Round	10.2 lb (14.9)

PLEASE CHECK THE FOLLOWING POINTS BEFORE REQUESTING REPAIR SERVICE.

PROBLEM	CHECK LIST
Completely out of order	<ul style="list-style-type: none"> • Check if the power plug is not connected • Check if the power supply or outlet has failed
Water does not spray out	<ul style="list-style-type: none"> • Check if the water supply is turned on • Check if water valve is open • Check if nozzle is blocked by foreign material • Check if connection hose is bent
Water pressure is low	<ul style="list-style-type: none"> • Check if screen filter is blocked and clean if needed. • Check if the water pressure is set at too low level.
Water is not warm enough	<ul style="list-style-type: none"> • Check if its temperature is set at off or low level, or economy mode
Seat is not warm enough	<ul style="list-style-type: none"> • Check if its temperature is set at off or low level, or economy mode
Water tank is drained intermittently	<ul style="list-style-type: none"> • Check if the automatic water draining feature activates.
Water is leaking	<ul style="list-style-type: none"> • Turn off the water supply valve and contact Bemis support.

2 YEAR WARRANTY

Your product is warranted against defects in materials or workmanship for (1) year from the date of original purchase. Defective parts or a defective products returned to Bio Bidet Innovation LLC will be repaired with new or comparable rebuilt parts or exchanged for a refurbished product as determined by Bio Bidet Innovation LLC in their sole discretion.

This limited warranty given by Bio Bidet Innovation LLC covers all defects encountered in normal product use, and do not apply in the following cases:

1. Loss of or damage to product due to abuse, misuse, tampering. Mishandling, improper packaging by you, alteration or fail to follow operating instructions.
2. Use of parts or supplies (other than those by Bio Bidet Innovation LLC dealers that cause damage to product.
3. Replacement of discolored or stained parts caused by chlorine, bleach, ammonia and other chemicals, cleaning supplies, oxidation, normal wear and tear.
4. Damage to or malfunction of the unit as a result of improper and negligent installation.
5. Any and all damages to plumbing, walls, floors, ceiling and personal properties resulting from water leaks or breakage. The product must be used at the user's own risk. Therefore, the owner hereby releases the manufacturer and distributor from any and all claims for damages where the above condition exists.

No implied warranty, including any implied warranty of merchantability or fitness or a particular purpose, applies to Bio Bidet Innovation LLC bidet after the applicable period of the express limited warranty stated above, and no other express warranty or guarantee, except as mentioned above, given by any person or entity with respect to Bio Bidet Innovation LLC shall bind Bio Bidet Innovation LLC, (Some States and provinces do not allow limitations on how long an implied warranty, so the above limitation may not apply to you) Bio Bidet Innovation LLC shall not be liable for revenues or profits, inconvenience, expense for substitute equipment or service, or any other special, incidental or consequential damages caused by the use or misuse of, or inability to use product, regardless of the possibility and foresee-ability of such damages. In no event shall recovery of any kind against Bio Bidet Innovation LLC be greater in amount than the purchase price of the product and causing the alleged damage. Without limiting the foregoing, you assume all risk and liability for loss, damage or injury to you and your property and to others and their property arising out of use or misuse of, or inability to use, the product not caused directly by the negligence or Bio Bidet Innovation LLC. This limited warranty shall not extend to anyone other than the original purchaser of the product.

Thank You



300 Mill Street
Sheboygan Falls, WI 53085
T: 920.467.4621

Bidets@Bemismfg.com
ToiletSeats.com